

Stitches and Seam Techniques - #134

Seen on 18th Century Garments in Various Museum Collections

The following notes have been gathered while attempting to learn stitches and construction techniques in use 200 years ago. The following is in no way a complete report, but only an indication of some techniques observed on extant 18th century garments.

Hopefully, others who are researching "actual" garments of the period in question will also report on their findings, so that comparisons can be made and a better total understanding achieved.

G. Ferris
July 1980

BACKSTITCH

Found on:

- 1) Essex Inst., Acc. #101.920 - Woman's Stays of Ticking fabric: backstitch used to create channels for boning.
- 2) Essex Inst., Acc. #101.670 - Woman's Stays of Linen (Acc. Card says cotton): backstitch used for channels for boning.
- 3) Essex. Inst., Acc. #109.900 - Child's Stays of Linen or Cotton: backstitch used to create channels for boning.
- 4) Boston Mus. F. A., Acc. #61.1034 —Man's Waistcoat, England: Quilted in very fine backstitch in herringbone pattern (also embroidered).
- 5) Germantown H.S., Acc. #663 —Man's breeches: Side seam, center back seam, crotch piecing and waist gusset all backstitched.

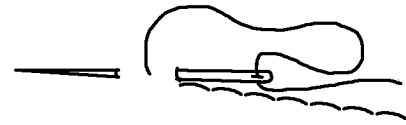

(The fell seam worked on a number of short gowns in the collection of Chester County Historical Society uses the backstitch as the first step. Please see listing "Fell seam worked on wrong side of garment".)

RUNNING STITCH

Found on:

- 1) Essex Inst., Acc. #108352 — Child's Dress: Side seam worked in running stitch.
- 2) Metropolitan Mus., Acc. #1974.194.2 —Woman's Dress, English 1780-85: Skirt panels joined by running stitch.
- 3) Williamsburg, Acc. #531-59 —Man's Coat, American: Running stitch used to attach lining to coat edge.
- 4) Chester County H.S., Acc. #00/75CLF98 —Woman's Short Gown: Pleats on back done by running stitch (pleats overcast down on inside garment).
- 5) Chester County H.S., Acc. #00/76CLF164 —Woman's Short Gown: Running stitch used to sew back pleats.
- 6) Chester County H.S., Acc. #00/76CLF183 —Woman's Short Gown: Running stitch used to sew back pleats (pleats overcast down on inside garment)
- 7) Germantown H.S. Acc. #511 —Woman's Short Gown: Running stitch used to sew back pleats.

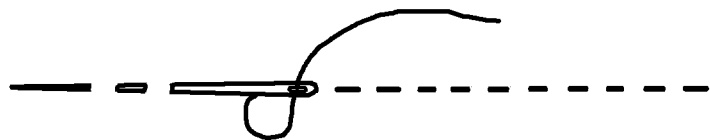

BUTTED SEAMS

(Two selvedge edges, or two folded edges, brought together edge to edge and overcast; join usually lays flat)

Found on:

- 1) Essex Inst., Acc. #108/177 — Woman's apron of blue and white check: Center seam butted.
- 2) Essex Inst., Acc. #101,033 — Woman's Dress of 1790-1810:

Piecing on sleeves done by butting and overcasting (seam allowance turned in first).

- 3) Williamsburg, Acc. #1956 — Woman's Dimity (embroidered) petticoat: Has a 3" strip near waist joined to Dimity with a selvedge edge and a folded edge joined by butting (the one raw edge then overcast).

- 4) Chester County H.S., Acc. #00/76CLF184 (also 189) — Woman's Short Gown: Piecing seam at front (on inside seam allowances folded back and overcast; raw edges then overcast).

- 5) Germantown H.S., Acc. #353 (or 55-103) — Man's Shirt, --also 3rd Shirt--without number: Both of these shirts have one side seam of body with selvedges butted together, the overcasting being done on the right side of the shirts.

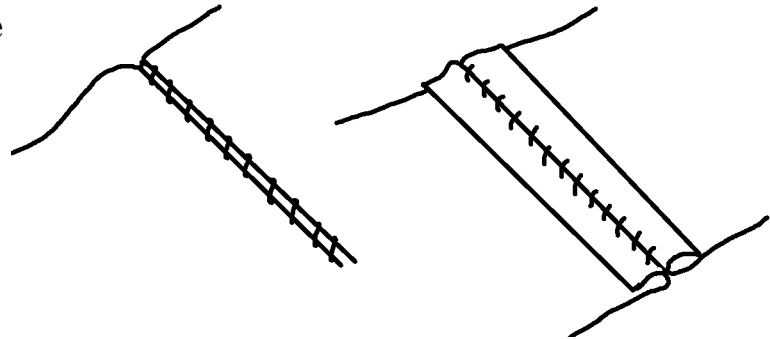

(This type of seam is commonly seen on old linens, i.e., sheets, tablecloths—also, blankets and coverlets.)

STAND-UP SEAM

(A seam which is first joined by running or backstitch; then turned in to the line of stitching and overcast. This creates a tubular effect.)

Found on:

- 1) Metropolitan Museum of Art, Acc.

#38.26a—Woman's Dress, American, Mid 18c: Center back skirt seam joined by running stitch. Then, edges folded in to stitching line and overcast. Result: seam stands up 1/4".

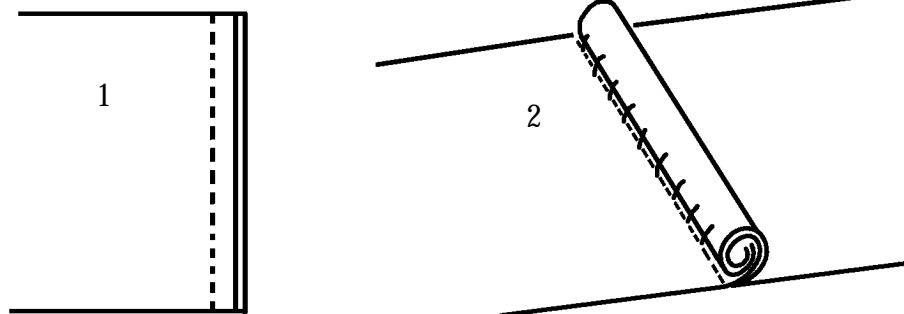

SEAMS SPREAD OPEN AFTER JOIN IS MADE

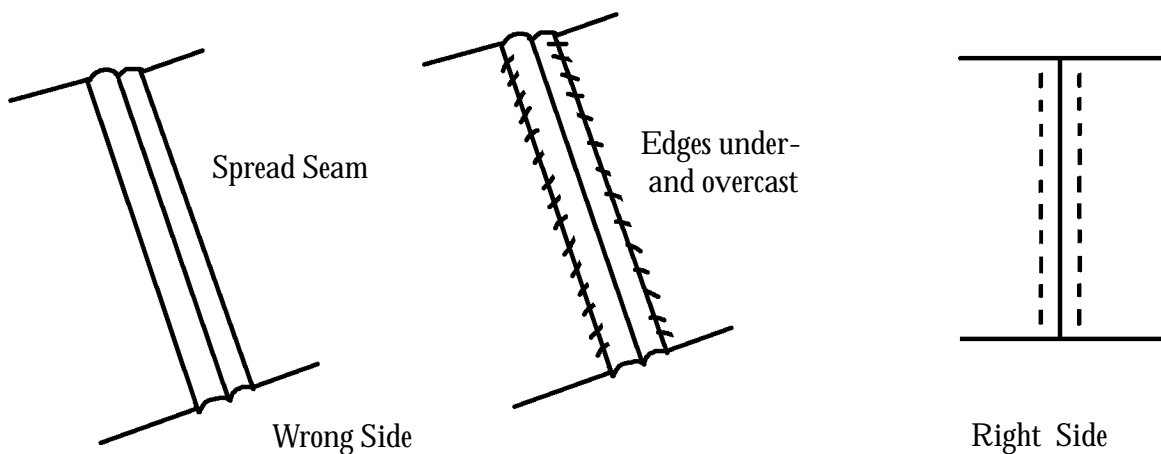

Found on:

- 1) Mt. Vernon (no Acc. Number) —G. Washington's breeches of twill linen: Center front seam appears to be opened and edges sewn down on inside. (Seen in case at Museum).
- 2) Chester County H.S., Acc. #00/76CLF183 —Woman's Short Gown: Piecing on lower front portion done right sides together, then seam opened and seam allowances folded back, edges turned under and overcast down.

"LAPPED" FELL SEAM

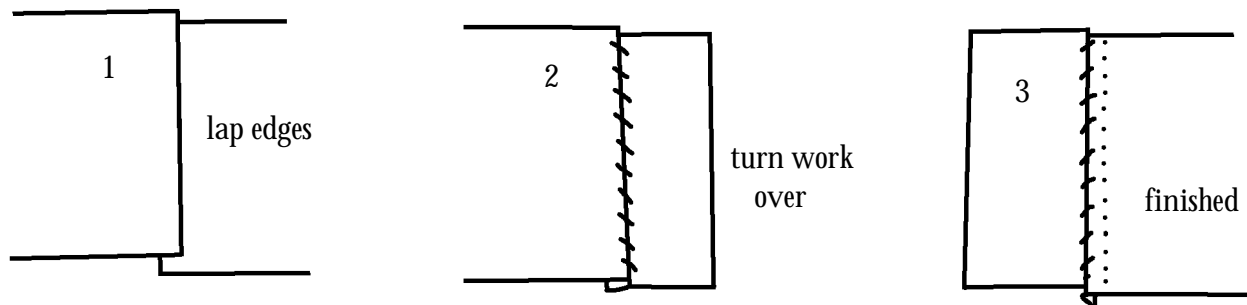

Where a seam in a garment is required, lap one edge over the other for a depth of approx. 1/2". Fold in the raw edge and overcast (whip) down. Turn garment to other side, fold in edge and overcast down. Seam finish will appear the same on both right and wrong sides of garment.

Found on:

- 1) Chester County H.S., Acc #00/76CLF185 —Woman's Short Gown: The sleeve join seam is done as described above.

FELL SEAM WORKED ON WRONG SIDE OF GARMENT

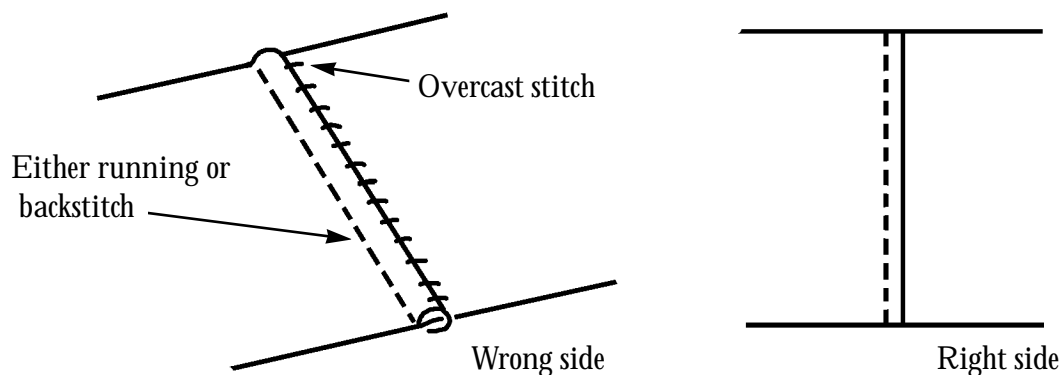

Found on:

- 1) Williamsburg, Acc. #1956.578—Woman's petticoat of Dimity: Side seam of garment joined with fell seam sewn on wrong side (inside).
- 2) Chester County H.S., Acc. #00/75CLF98 —Short Gown: Side seams sewn with backstitch, then seam allowance (to one side) turned under and overcast down.
- 3) Chester County H.S., Acc #00/76CLF164—Woman's Short Gown: seams same as #2 above.
- 4) Chester County H.S., Acc #00/76CLF183 —Woman's Short Gown: Sleeves joined with running stitch; seam to one side, edges turned under and overcast—done on wrong side.
- 5) Chester County H.S., Acc. #00/76CLF185—Woman's Short Gown: Side seams backstitched, felled and overcast as in above examples. Seam result 1/4".
- 6) Chester County H.S., Acc. #00/76CLF184—(also 189)—Woman's Short Gown: Main side seams and sleeve joins done with backstitch, felled and overcast as above examples.
- 7) Germantown H.S., Acc. #511—Woman's Short Gown: Main side seams same as above examples of seam on short gowns—resultant width of seam approx. 1/8".
- 8) Germantown H.S., Acc. #89-184—Man's Shirt: Side seams done with running stitch, felled and overcast as above examples. Result: 1/8" width.
- 9) Germantown H.S., Acc. #353 (or 55-103)—Man's Shirt: Sleeve seams—same as above. Result: approx. 1/8" width.
- 10) Germantown H.S., (No number)—Man's Shirt: Sleeve joins done with backstitch and running stitch, felled and overcast with 1/8" result. Underarm seam done similarly.

A note from Claudia Kidwell's article "Short Gowns" which appeared in DRESS:

Footnote 25 (page 39 or article) "The modern technique for making a flat-fell seam (illustrated in The Fashion Dictionary written by Mary Brooks Picken and Published in New York, 1957 produces a flatter seam finishing than appears in any of the twenty-eight short gowns. Three other methods for producing a similar but thicker seam finish were described in the 1840 London publication, The Work Woman's Guide (pp. 2-3)."

FELL SEAM WORKED ON WRONG SIDE OF GARMENT (con't)

A further note concerning “fell” seams:

In *Rural Pennsylvania Clothing* by Ellen J. Gehret, instructions for making a “flat felled Seam” are given on page 24. A question develops as the short gown pictured on pages 42 and 43 of her book, and the man’s shirt shown on pages 122 and 124, both have fell seams worked on the wrong (inside) of the garments, and Gehret gives instructions for another method (a modern technique?). Why the author chose to ignore the old method is not entirely clear.

However, in talking to Ellen Gehret by phone on two occasions, two items became clearer. Ellen Gehret encouraged me to use the method seen on the original garments (this conversation predated any of my research), and also she mentioned that she had not seen personally the shirts which are shown in the photos from the Germantown H.S.

I leave it to the individual to research and decide for himself on the question of this seam technique.

WOMEN’S SLEEVE PLEATS SEWN DOWN

(more usual to seem them left open)

Found on:

- 1) Metropolitan Mus., Acc. #1974.194.2–Woman’s Gown, English, figured Chintz.

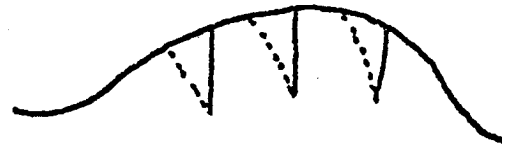

SLEEVES OF SET-IN TYPE

(SLEEVE AND LINING TREATED AS ONE AND THEN SEWN IN)

Found on:

- 1) Essex Inst., Acc. #101,033–Woman’s Dress: Sleeve sewn in with backstitch.
- 2) Metropolitan Mus., Acc. #1974.194.2–Woman’s Dress, English 1780-85: Sleeve sewn in with backstitch.
- 3) Metropolitan Mus., Acc. #26.38a–Woman’s Dress, American: Sleeves sewn in with backstitch.
- 4) Metropolitan Mus., Acc. #38.26a–Woman’s Dress, American, Mid 18c.

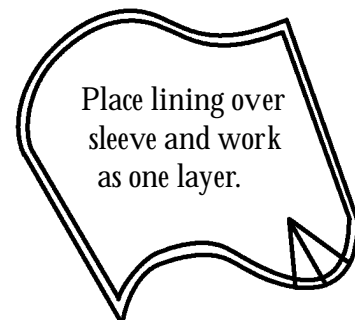

FINISHES ON RAW EDGES OF SEAMS

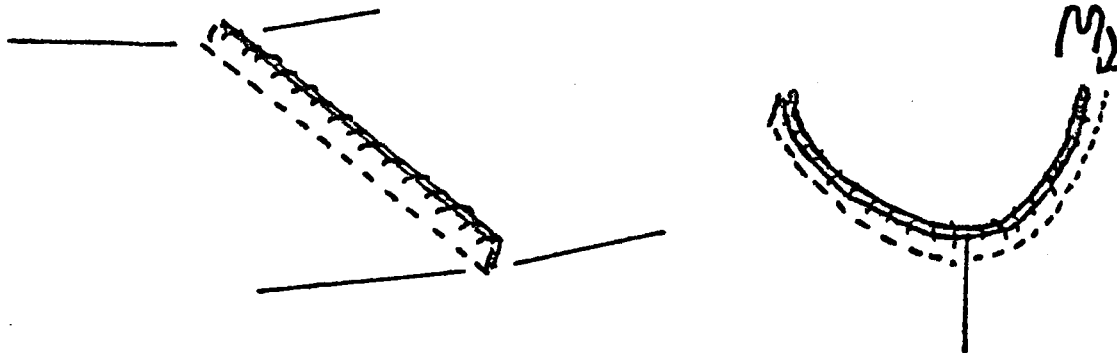

Found on:

- 1) Essex Inst., Acc. #108352–Child's Dress: Seam done with running stitch, then raw edges overcast together.
- 2) Chester County H.S., Acc. #00/76CLF184 (also 189)–Woman's Short Gown: On piecing, raw edges overcast with large overcast stitches.
- 3) Germantown H.S., Acc. #663–Man's Breeches: On center back seam, raw edges overcast together.
- 4) Metropolitan Mus., Acc. #CI-64.32.2a(b)–Woman's Sack Gown of Cotton Chintz: Armhole seam raw edges turned in and overcast

NARROW HEMS AT EDGES OF GARMENT

Found on:

- 1) Essex Inst., Acc. #1208352–Child's Dress: Hem done by running stitch.
- 2) Chester County H.S., Acc. #00/75CLF98–Woman's Short Gown: Narrow hems on sleeve ends and hem of garment (1/8" to 1/4")
- 3) Chester County H.S., Acc. #00/76CLF164–Woman's Short Gown: Hems as in No. 2 above.
- 4) Chester County H.S., Acc. #00/769CLF183–Woman's Short Gown:--Hems 1/4 done with overcast stitch.
- 5) Germantown H.S., Acc. #511–Woman's Short Gown: Very narrow hems on edges 1/8".
- 6) Germantown H.S., Acc. #353 (or 55-103) Man's Shirt: Bottom hem 1/8" overcast.

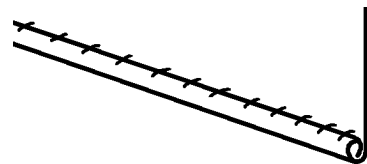

TOP STITCHING OF SEAMS



Found on:

- 1) Metropolitan Mus., Acc #147.2–Woman's Riding Jacket, c. 1775.
- 2) Metropolitan Mus., Acc. #26.233.9–Woman's Dressing Gown, French (Indian Calico): Backstitch done in red approx. 1" in from seams.
- 3) Germantown H.S., Acc. #89-184–Man's Shirt: Bands of counted backstitching on right side of garment.

EMBROIDERY ON GARMENTS

Found on:

- 1) Metropolitan Mus., Acc. #3895.A–Woman's Gown, French, linen: Embroidery very fine chain stitch polychrome.
- 2) Boston Mus. F.A., Acc. #38.1297–Man's Negligee Cap, France 1750-1800: Embroidery fine chain stitch.
- 3) Boston Mus. F.A. Acc. #38.1315–Man's Negligee Cap, Europe 1700-1750: Silk embroidered with straw. Straw looks like gold.

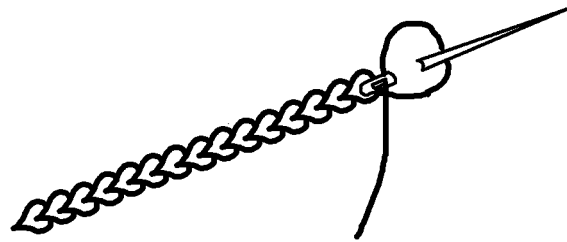

REFERENCES

Arnold, Janet. *A Handbook of Costume*. MacMillan, N. Y, 1973. (Very helpful–Chapter II – “Dating Costumes from Construction Techniques”)

Gehret, Ellen J. *Rural Pennsylvania Clothing, Being a Study of the Wearing Apparel of the German and English Inhabitants Both Men and Women Who Resided in Southeastern Pennsylvania in the Late Eighteenth and Early Nineteenth Century*. Liberty Cap. Books, York, PA , 1976.

Waugh, Norah. *The Cut of Women's Clothes 1600-1930*. Theatre Arts Books, N.Y., 1968. (Cutting diagrams, scaled drawings).

Periodicals:

Kidwell, Claudia. Dress. “Short Gowns”, 1979 (Journal of the Costume Society.)